

Getting Started with AT32F413

Introduction

This application note is written to help users with rapid project development using AT32F413xx.

Note: The corresponding code in this application note is developed on the basis of V2.x.x BSP provided by Artery. For other versions of BSP, please pay attention to the differences in usage.

Applicable products:

Part number	AT32F413xx
-------------	------------

Contents

1	Preliminary environment requirements	6
1.1	Build AT32 development environment.....	6
1.1.1	Debug tools and evaluation board.....	6
1.1.2	Programming tools and software.....	7
1.1.3	AT32 development environment.....	7
1.1.4	How to replace SXX.....	13
1.2	AT32F413 chip enhanced functions	13
1.2.1	PLL clock settings.....	13
1.2.2	How to enable FPU function.....	15
1.2.3	AT32F413 zero-wait/non-zero-wait Flash and embedded SRAM configurations.....	17
1.2.4	Encryption mode (access protection /erase and program protection /external Flash encryption).....	19
1.2.5	Recognize AT32 MCU in program.....	24
2	FAQs in downloading/compiling	25
2.1	Hard Fault Handler.....	25
2.2	J-Link cannot find IC	25
2.3	Problems in program downloading	25
2.3.1	Error: Flash Download failed–“Cortex-M4”	25
2.3.2	No Debug Unit Device found.....	26
2.3.3	RDDI-DAP Error.....	26
2.3.4	ISP serial port gets stuck in downloading	26
2.3.5	Resume download	26
3	Security Library (sLib)	29
3.1	Introduction	29
3.2	Principles of application	29
3.3	Security library application	29
4	Revision history	30

List of tables

Table 1. Document revision history 30

List of figures

Figure 1. AT-START-F413 evaluation board with AT-Link-EZ.....	6
Figure 2. AT-START-F413 evaluation board package.....	6
Figure 3. ICP/ISP/AT-Link-Family.....	7
Figure 4. BSP package.....	8
Figure 5. Keil_v5 templates	8
Figure 6. Pack download	9
Figure 7. Set up ArteryTek.AT32F413 _DFP	9
Figure 8. Set up Keil4_AT32MCU_AddOn	9
Figure 9. Pack Installer icon in Keil.....	10
Figure 10. Set up IAR_AT32MCU_AddOn	10
Figure 11. Keil Debug option.....	11
Figure 12. Keil Debug Settings	11
Figure 13. Keil Utilities	11
Figure 14. IAR Debug option	12
Figure 15. IAR CMSIS-DAP option	12
Figure 16. Use SXX32F103 to output 200 MHz clock on AT32F413.....	13
Figure 17. AT32F413 crm_pll_output_range parameter	13
Figure 18. New Clock Configuration.....	14
Figure 19. SXX PLL auto step-by-step switch configurations.....	14
Figure 20. AT32 PLL auto step-by-step switch configurations.....	15
Figure 21. Enable FPU in Keil.....	15
Figure 22. Add FPU enabling codes in Keil.....	16
Figure 23. Enable FPU in IAR.....	16
Figure 24. Add FPU enabling codes in IAR	16
Figure 25. User system data in ICP Programmer.....	17
Figure 26. Select SRAM size in user system data.....	18
Figure 27. Edit user system data in ISP Programmer	18
Figure 28. User system data setting in ISP Multi-Port Programmer	19
Figure 29. Enable access protection in ISP Programmer	20
Figure 30. Disable access protection in ISP Programmer.....	20
Figure 31. Enable erase and program protection in ICP Programmer	21
Figure 32. Disable erase and program protection in ICP Programmer.....	22
Figure 33. Encrypt external memory in ICP Programmer	23

Figure 34. Encrypt external memory in ISP Programmer	23
Figure 35. Read Cortex ID	24
Figure 36. Read PID and UID	24
Figure 37. Add FPU enabling codes.....	25
Figure 38. Flash Download failed–“Cortex- M4” pops up in downloading	26
Figure 39. Operate ConfigJLink_V1.0.0 in KEIL	27
Figure 40. ConfigJLink_V1.0.0 execution progress in KEIL	27
Figure 41. Operate ConfigJLink_V1.0.0 in IAR.....	28
Figure 42. ConfigJLink_V1.0.0 execution progress in IAR	28

1 Preliminary environment requirements

Download development environment

- [ARTERY's official website](#)

1.1 Build AT32 development environment

1.1.1 Debug tools and evaluation board

The AT32F413 evaluation board has an AT-Link-EZ debug tool, as shown in the red box in Figure 1 below. The AT-Link-EZ can be disassembled and used with other circuit boards, supporting IDE online debugging, online programming and USB-to-serial port.

Figure 1. AT-START-F413 evaluation board with AT-Link-EZ

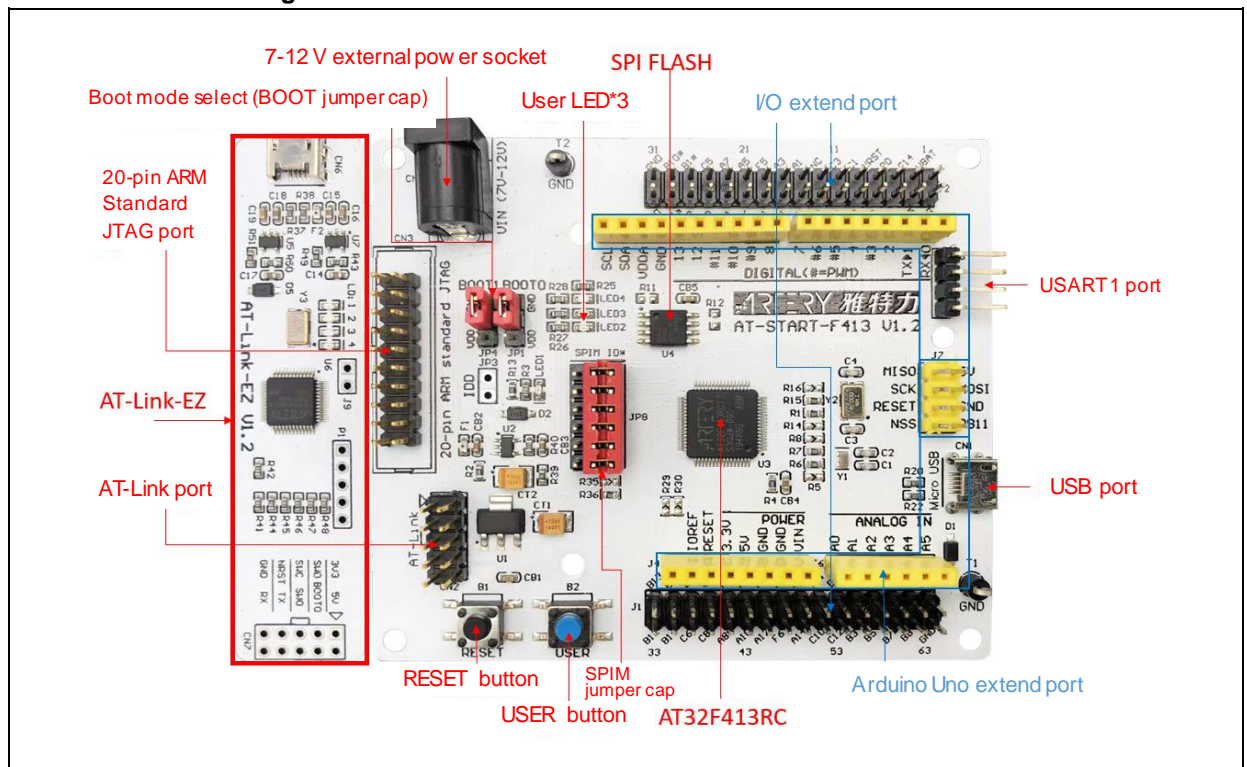

Note: For details about resources for AT-START evaluation board, please refer to *UM_AT_START_F413_Vx.x*. Path: [ARTERY's official website](#)→PRODUCTS→Mainstream→AT32F4xx; download and unzip Evaluation Board package, and get the "AT_START_F413_Vx.x\03_Documents".

Figure 2. AT-START-F413 evaluation board package

Evaluation Board		
Download	Description	Version
AT-START-F413	AT32F413 evaluation board supporting Arduino standard interfaces	V1.2

1.1.2 Programming tools and software

- AT programming tools and software: AT-Link / AT-Link+ /AT-Link-Pro / AT-Link-ISO /AT-Link-EZ, ICP/ISP.
- 3rd party programming tools: J-Link, Armfly, Alientek, XWOPEN, ICWORKSHOP, ZLG, MaxWiz, Amomcu, Acroview, Forcreat, Galecomm, Prosystems, Rx-prog, Sinaen, XELTEK, Zhifeng, etc.

Note: For more information, please visit [ARTERY's official website](#)→SUPPORT→Hardware Development Tool and 3RD Party Writer.

- For ICP usage instructions, please refer to *UM_ICP_Programmer*. Path: [ARTERY's official website](#)→PRODUCTS→Mainstream→AT32F4xx; download and unzip ICP tool, and get the "Artery_ICP_Programmer_Vx.x.xx\Document\UM_ICP_Programmer".
- For ISP usage instructions, please refer to *UM_ISP_Programmer*. Path: [ARTERY's official website](#)→PRODUCTS→Mainstream→AT32F4xx; download and unzip ISP tool, and get the "Artery_ISP_Programmer_Vx.x.xx\Document\UM_ISP_Programmer".
- For AT-Link usage instructions, please refer to *UM0004_AT-Link_User_Manual*. Path: [ARTERY's official website](#)→PRODUCTS→Mainstream→AT32F4xx; download and unzip AT-Link-Family, and get the "AT_Link_CH_Vx.x.x\05_Documents\UM0004_AT-Link_User_Manual_ZH_Vx.x.x".

Figure 3. ICP/ISP/AT-Link-Family

Tool		
Download	Description	Version
AT32 IDE_Linux AT32 IDE_Windows	支持AT32 MCU的基于Eclipse开发的跨平台ARM嵌入式系统的软件开发环境	V1.0.02
AT-Link Family	支持AT32 MCU 仿真与在线/离线烧录工具 (包含AT-Link-EZ/AT-Link/AT-Link-Pro/AT-Link-ISO四种工具)	V2.1.1
AT-Link Console	支持AT32 MCU 「在电路编程」 Console工具	V3.0.02
ICP	支持AT32 MCU 「在电路编程」工具	V3.0.05
ISP	支持AT32 MCU 「在系统编程」工具	V2.0.06
ISP Multi-Port	支持AT32 MCU一对多设备「在系统编程」工具	V2.0.06

1.1.3 AT32 development environment

1.1.3.1 Template projects

The commonly used IDE template projects are available from BSP provided by ArteryTek. BSP path: [ARTERY's official website](#)→PRODUCTS→Mainstream→AT32F4xx.

Figure 4. BSP package

BSP		
Download	Description	Version
Firmware Library	AT32F413 firmware library BSP user guide	V2.0.9

The template projects of Keil_v5/Keil_v4/IAR_6.10/IAR_7.4/IAR_8.2/eclipse_gcc/at32_ide are created in BSP. Path: AT32F413_Firmware_Library_V2.x.x\project\at_start_f4xx\templates. Open the project folder and click on the project file to open the corresponding IDE project. The example of Keil_v5 template project is shown below.

Figure 5. Keil_v5 templates

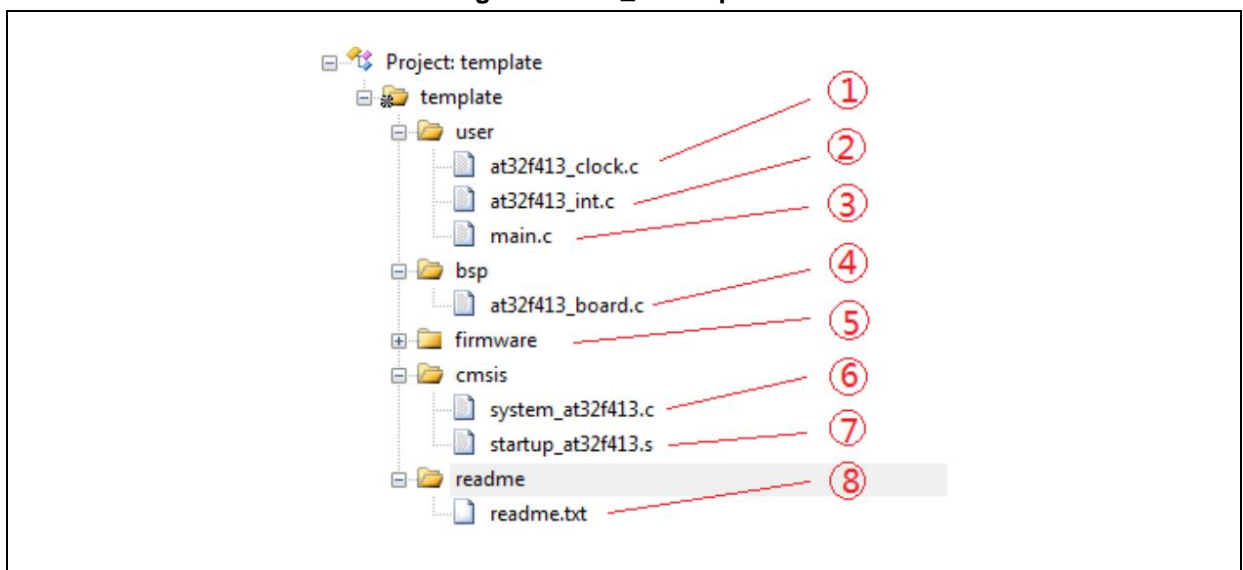

Contents in the project:

- ① at32f413_clock.c: clock configuration file, contains default clock frequency and clock path;
- ② at32f413_int.c: interrupt file, part of core interrupt function code flow is written by default;
- ③ main.c: main code file of the template project;
- ④ at32f413_board.c: board-level configuration file, contains settings of AT-START on-board buttons and LEDs;
- ⑤ at32f413_xx.c under *firmware*: driver file of on-chip peripherals;
- ⑥ system_at32f413.c: system initialization file;
- ⑦ startup_at32f413.s: startup file;
- ⑧ readme.txt: project documentation, contains application functions, setting methods and associated application notes (ApNote) of the template project.

Except for templates, BSP also includes code examples (Keil_v5 project files) in terms of peripherals for reference (AT32F413_Firmware_Library_V2.x.x\project\at_start_f4xx\examples).

Note: For more details about BSP, please refer to "Section 4 BSP application" of AT32F413 Firmware BSP&Pack User Guide. Path: [ARTERY's official website](#)→PRODUCTS→Mainstream→AT32F4xx; download and unzip BSP, and get the "AT32F413_Firmware_Library_Vx.x.x\document".

1.1.3.2 Pack installation

Install Pack and add the AT32 MCU part number to Keil/IAR. You can download Pack from [ARTERY's official website](#)→PRODUCTS→Mainstream→AT32F4xx.

Figure 6. Pack download

Download	Description	Version	Date
Keil 4 Keil 5	Supports AT32 MCU to run in Keil MDK	V2.2.0 V2.2.3	2023.07.07
IAR	Supports AT32 MCU to run in IAR EWARM	V2.1.6	2023.07.07
Segger	Supports Segger tools to identify AT32 MCU	V2.0.7	2023.03.17
ConfigJLink	How to resume download for AT32 series	V1.0.1	2019.02.26

For Keil compiling system, keil 4.74 /5.23 or above is recommended. If Keil_v5 is used, please unzip Keil5_AT32MCU_AddOn and install the corresponding ArteryTek.AT32F413_DFP. If Keil_v4 is used, please install Keil4_AT32MCU_AddOn. By default, the Keil installation path can be recognized automatically during installation. If the path is not recognized or incorrect, you need to manually select the Keil installation path.

Figure 7. Set up ArteryTek.AT32F413 _DFP

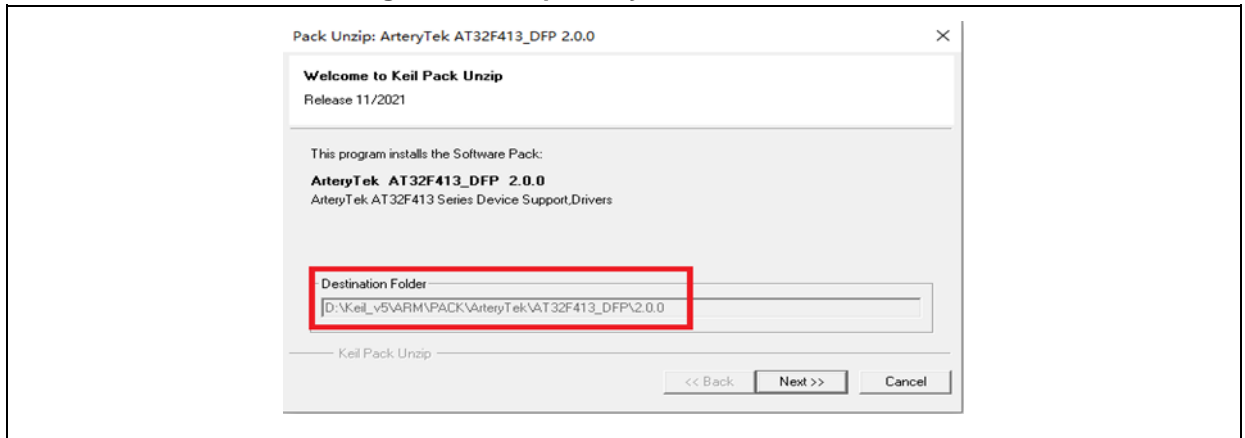
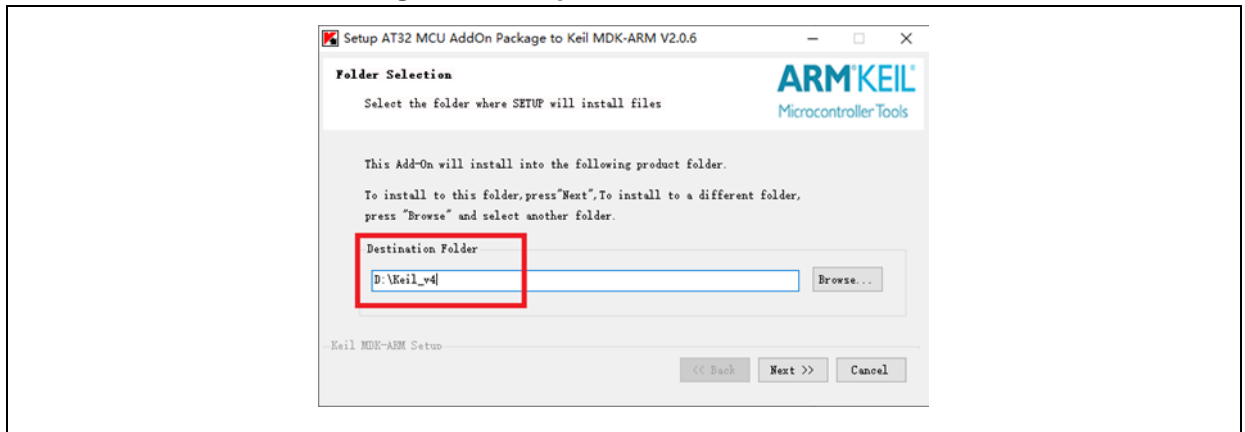
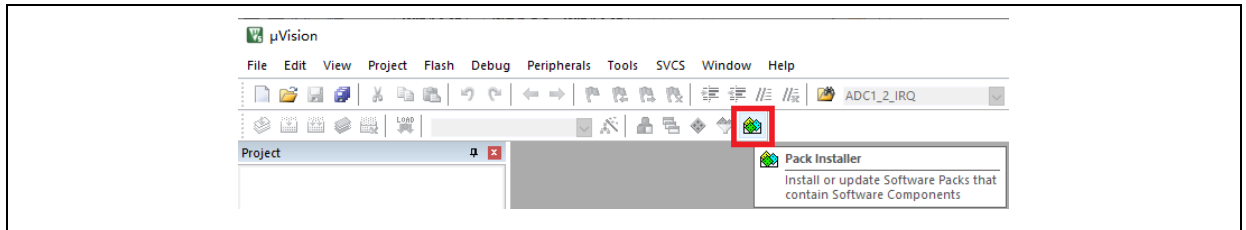

Figure 8. Set up Keil4_AT32MCU_AddOn



You can also open Keil and click on “Pack Installer” icon; then click on the top left “file” and select “import” to import the corresponding pack downloaded from [ARTERY's official website](#).

Figure 9. Pack Installer icon in Keil



For IAR compiling system, IAR7.0 / IAR6.1 or above is recommended. It is necessary to install IAR_AT32MCU_AddOn. By default, the IAR installation path can be recognized automatically during installation. If the path is not recognized or incorrect, you need to manually select the IAR installation path.

Figure 10. Set up IAR_AT32MCU_AddOn

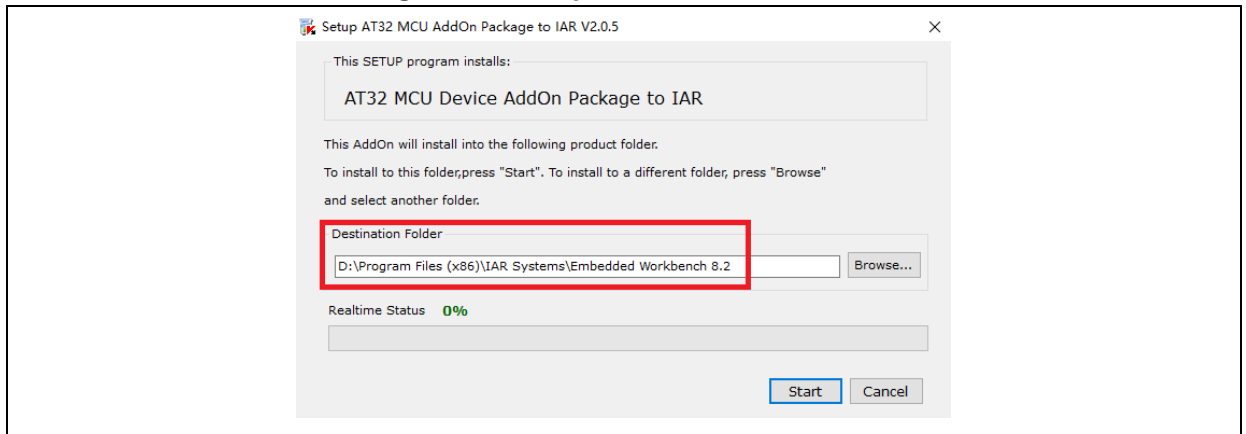

Note: For more details about Pack setup, please refer to “Section 2 Pack setup” of AT32F413 Firmware BSP&Pack User Guide. Path: [ARTERY's official website](#)→PRODUCTS→Mainstream→AT32F4xx; download and unzip BSP, and get the “AT32F413_Firmware_Library_Vx.x.x\document”.

1.1.3.3 Use AT-Link for debug and download

If you want to use AT-Link in IAR, select CMSIS-DAP in Debugger option.

Figure 11. Keil Debug option

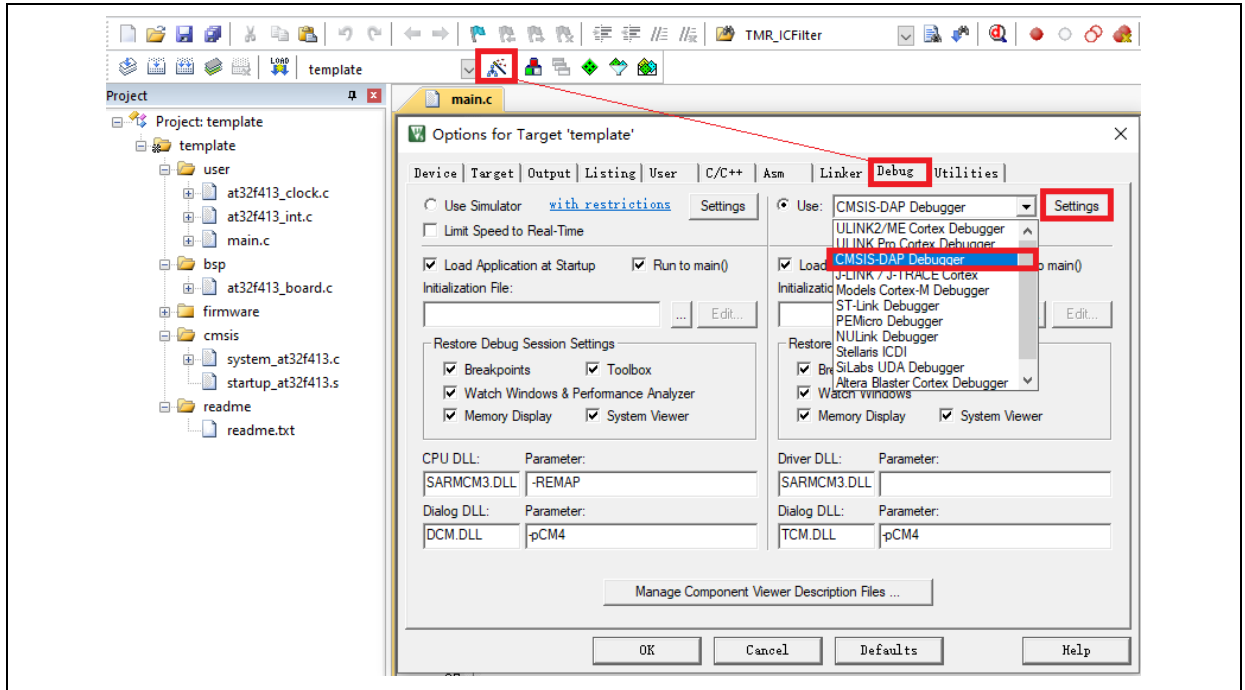

Go to Debug and click on Settings to enter the Cortex-M Target Driver Setup interface.

1. Select AT-Link(WinUSB)-CMSIS-DAP/AT-Link-CMSIS-DAP;

Note: For details about WinUSB, please refer to FAQ0136_How to use AT-LINK WinUSB to improve download speed ([ARTERY's official website](#)→SUPPORT→FAQ→FAQ0136).

2. Find Port, select SW and then tick SWJ;
3. Confirm that the ARM SW-DP debug module is recognized.

Figure 12. Keil Debug Settings

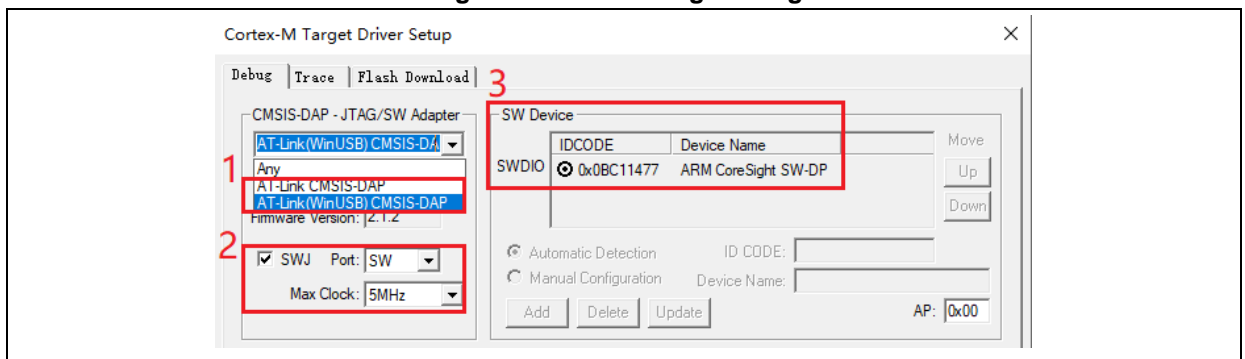

Click on Utilities and untick option box 1; then select CMSIS-DAP Debugger in option box 2, and finally tick option box 1 (it should be unticked first and then ticked).

Figure 13. Keil Utilities

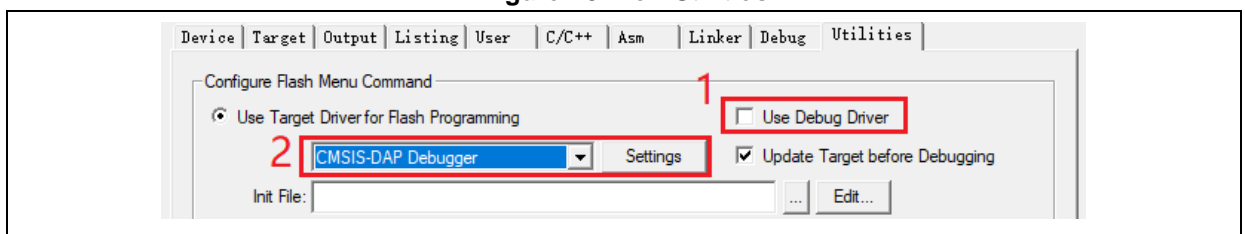

If you want to use AT-Link in IAR, please click on Project and select Options; then select CMSIS-DAP in Debugger option, and select SWD in CMSIS DAP option.

Figure 14. IAR Debug option

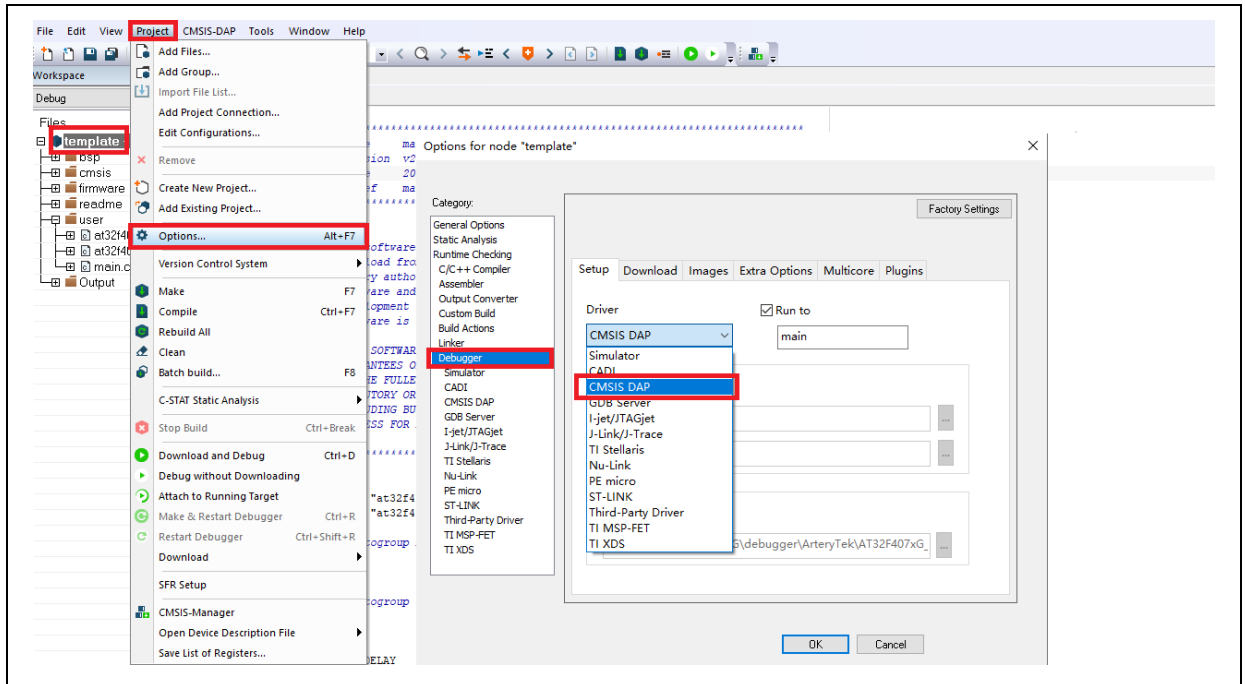
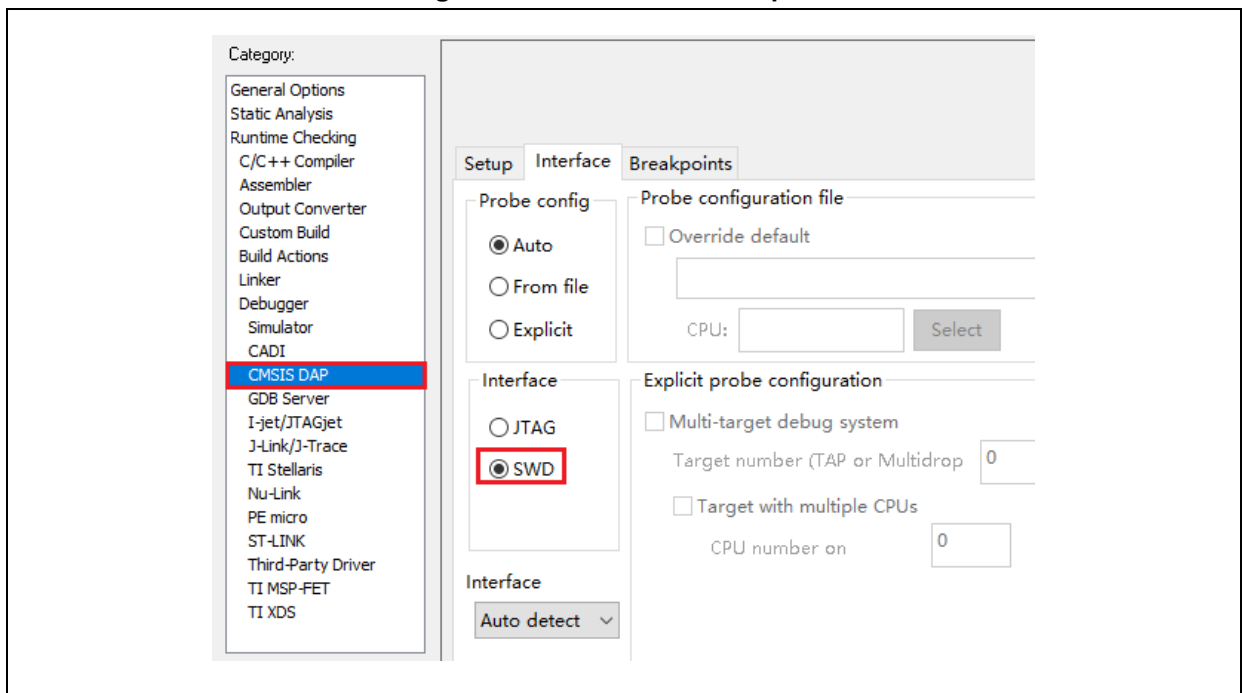

Figure 15. IAR CMSIS-DAP option



Note: For details about Flash algorithm file, MCU switch and solutions for “J-Link cannot find MCU”, please refer to AT32F413 Firmware BSP&Pack User Guide. Path: [ARTERY's official website](#)→PRODUCTS→Mainstream →AT32F4xx; download and unzip BSP, and get the “AT32F413_Firmware_Library_Vx.x.x\document”.

1.1.4 How to replace SXX

- Step 1: Compare the peripheral specifications, Flash size and SRAM size, etc.; unsolder SXX32F103 and replace it with the corresponding AT32F413 part;
- Step 2: Use ARTERY ICP/ISP or KEIL/ IAR and download SXX32F103 HEX files or BIN files;
- Step 3: If necessary, download other materials together with SXX32F103 HEX files or BIN files, or perform system calibration;
- Step 4: Check if the program can run normally;
- Step 5: For other issues, please refer to *MG0003_ Migrating from SXX32F103 to AT32F413* ([ARTERY's official website](#)→PRODUCTS→Mainstream→AT32F4xx);
- Step 6: If the program still cannot run properly after completing the above steps, please refer to other sections of this application note or contact the agent and ARTERY technicians for help.

Note: Due to the flexible memory expansion design of AT32F413, its internal Flash memory has non-zero wait area, which may cause poor performance of some SXX32F103 programs on AT32F413. In this case, please refer to AN0004_Performance_Optimization ([ARTERY's official website](#)→SUPPORT→AP Note→AN0004).

1.2 AT32F413 chip enhanced functions

1.2.1 PLL clock settings

1.2.1.1 PLL greater than 72 MHz

The internal PLL of AT32F413 has a maximum output frequency of 200 MHz, and settings are slightly different when the clock is greater than 72 MHz. The user needs to set the PLLRANGE register according to the output frequency (PLL>72 MHz, PLLRANGE=1; PLL≤72 MHz, PLLRANGE=0).

When the SXX32F103 BSP is used, the PLL setting example (HEXT=8 MHz, PLL=72 MHz)

```
RCC->CFGR |= (uint32_t)(RCC_CFGR_PLLSRC_HSE | RCC_CFGR_PLLMULL9);
```

If the user wants to use SXX32F103 program to output a lock greater than 72 MHz on AT32F413, it is necessary to configure the PLLRANGE bit.

When PLL=200 MHz, the corresponding setting is as follows:

Figure 16. Use SXX32F103 to output 200 MHz clock on AT32F413

```
#define RCC_CFG_PLLRANGE_GT72MHZ ((uint32_t)0x80000000)
/*!< When PLL frequency is greater than 72MHz */
RCC->CFGR |= (uint32_t)(RCC_CFGR_PLLSRC_HSE | RCC_CFGR_PLLMULL25 |
RCC_CFG_PLLRANGE_GT72MHZ);
```

When the AT32F413 BSP is used, the PLL setting example (HEXT=8 MHz)

Figure 17. AT32F413 crm_pll_output_range parameter

```
typedef enum
{
    CRM_PLL_OUTPUT_RANGE_LE72MHZ= 0x00, /*!< pll clock output range less than or equal to 72mhz */
```

```

CRM_PLL_OUTPUT_RANGE_GT72MHZ= 0x01 /*!< pll clock output range greater than 72mhz */
} crm_pll_output_range_type;

```

When PLL=72 MHz, the corresponding setting is as follows:

```

crm_pll_config(CRM_PLL_SOURCE_HEX_T_DIV, CRM_PLL_MULT_18, CRM_PLL_OUTPUT_RANGE_LE72MHZ);

```

When PLL=200 MHz, the corresponding setting is as follows:

```

crm_pll_config(CRM_PLL_SOURCE_HEX_T_DIV, CRM_PLL_MULT_50, CRM_PLL_OUTPUT_RANGE_GT72MHZ);

```

For details about clock configurations, please refer to AN0118_AT32F413_CRM_Start_Guide ([ARTERY's official website](#)→SUPPORT→AP Note→AN0118) to learn how to configure and modify AT32F413 clock source codes and use New Clock Configuration ([ARTERY's official website](#)→PRODUCTS→Mainstream→AT32F4xx) to generate the desired clock code and apply it to the project.

Figure 18. New Clock Configuration

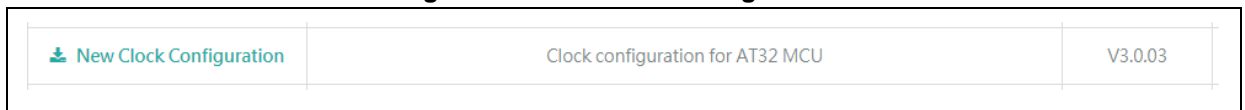

1.2.1.2 Auto step-by-step clock switch

When the internal PLL of AT32F413 is set to 108 MHz and above, it is necessary to perform auto step-by-step clock switch function.

When the SXX32F103 program is used, the user needs to open system_Sxx32f10x.c, find out the current system clock frequency configuration function (go through Section 1.2.1.1 PLL settings), and add the following codes in *Italic black* to the *static void SetSysClockToxxM(void)* function.

Figure 19. SXX PLL auto step-by-step switch configurations

```

/* Wait till PLL is ready */
while((RCC->CR & RCC_CR_PLLRDY) == 0)
{
}
*((unsigned int *)0x40021054) |= (0x30); // Enable auto step-by-step clock switch function
/* Select PLL as system clock source */
RCC->CFGR &= (uint32_t)((uint32_t)~(RCC_CFGR_SW));
RCC->CFGR |= (uint32_t)RCC_CFGR_SW_PLL;
/* Wait till PLL is used as system clock source */
while ((RCC->CFGR & (uint32_t)RCC_CFGR_SWS) != (uint32_t)0x08)
{
}
*((unsigned int *)0x40021054) &=~ (0x30); // Disable auto step-by-step clock switch function

```

When the AT32F413 BSP is used, the example of PLL auto step-by-step switch is shown below:

Figure 20. AT32 PLL auto step-by-step switch configurations

```

/* enable auto step mode */
crm_auto_step_mode_enable(TRUE);

/* select pll as system clock source */
crm_sysclk_switch(CRM_SCLK_PLL);

/* wait till pll is used as system clock source */
while(crm_sysclk_switch_status_get() != CRM_SCLK_PLL)
{
}

/* disable auto step mode */
crm_auto_step_mode_enable(FALSE);

/* update system_core_clock global variable */
system_core_clock_update();

```

Note: If the auto step-by-step system clock switch is enabled, it must be disabled after clock switch.

1.2.2 How to enable FPU function

There are two conditions in Keil:

- ① Use AT32F413 BSP/Pack or the modified SXX BSP/Pack to modify the Floating Point Hardware.

Figure 21. Enable FPU in Keil

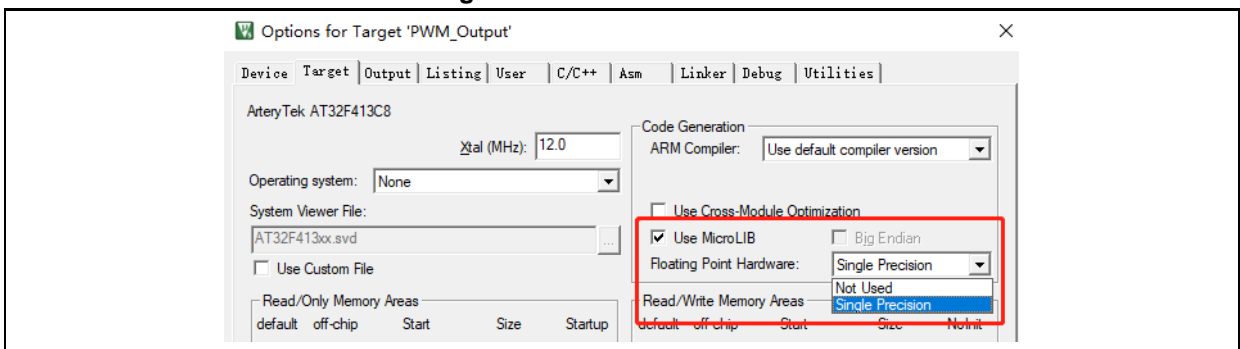

- ② SXX32F10X does not support FPU function. If the user wants to enable FPU function in the developed project in SXX library, the following operations should be done:
 - Refer to *AT32F413 Firmware BSP&Pack User Guide* to set up Keil PACK and modify the relevant header files;
 - Select the corresponding AT part number in Options—Target;
 - Add the following configuration codes at the beginning of SystemInit function of system_stm32f10x.c, and add cm4.h to the project.

Figure 22. Add FPU enabling codes in Keil

```

/* Enable FPU*/

#if defined (__FPU_USED) && (__FPU_USED == 1U)
    SCB->CPACR |= ((3U << 10U * 2U) |           /* set CP10 Full Access */
                  (3U << 11U * 2U) );         /* set CP11 Full Access */
#endif
    
```

There are two conditions in IAR:

- ① Use AT32F413 BSP/Pack or the modified SXX BSP/Pack to modify the Floating Point Hardware.

Figure 23. Enable FPU in IAR

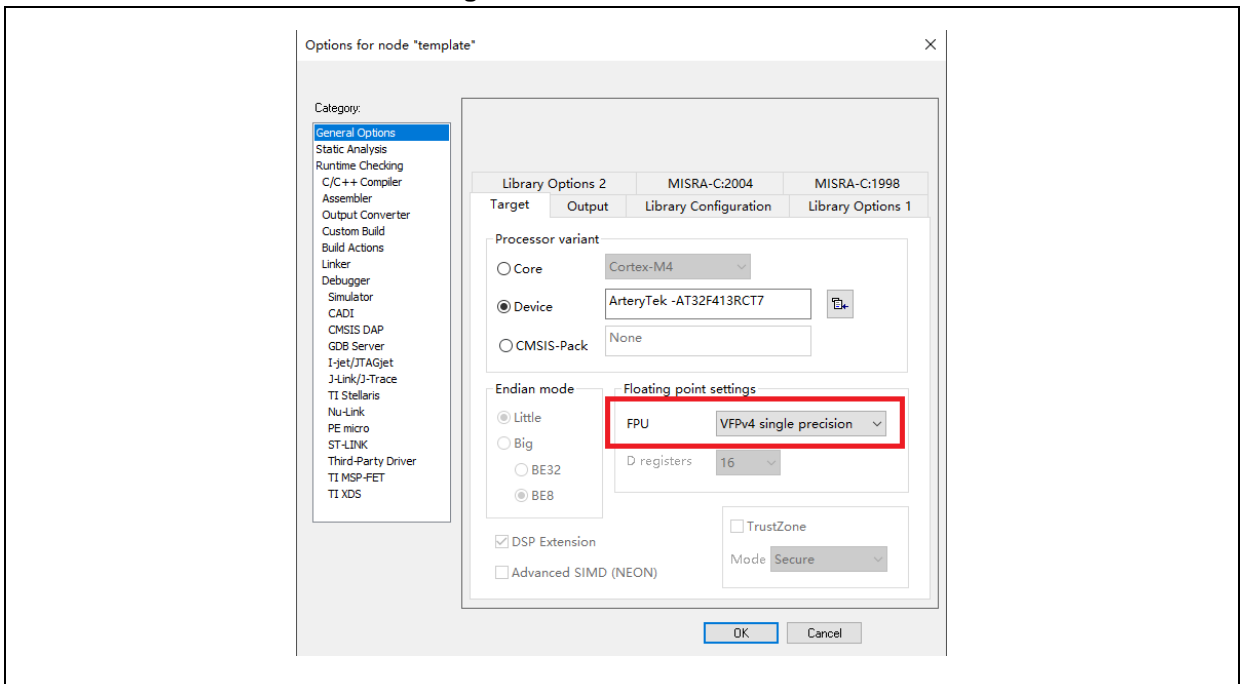

- ② SXX32F10X does not support FPU function. If the user wants to enable FPU function in the developed project in SXX library, the following operations should be done:

- Refer to *AT32F413 Firmware Library BSP&Pack User Guide* to set up IAR PACK and modify the relevant header files;
- Select the corresponding AT32 part number in General Options—Target;
- Add the following configuration codes at the beginning of SystemInit function of system_stm32f10x.c, and add cm4.h to the project.

Figure 24. Add FPU enabling codes in IAR

```

/* Enable FPU*/

#if defined (__FPU_USED) && (__FPU_USED == 1U)
    SCB->CPACR |= ((3U << 10U * 2U) |           /* set CP10 Full Access */
                  (3U << 11U * 2U) );         /* set CP11 Full Access */
#endif
    
```

For more information, please refer to AN0037_How_to_use_FPU ([ARTERY's official website](#)→ SUPPORT→AP Note→AN0037), which details how to use FPU function on AT32 MCU and configurations in Keil / IAR.

1.2.3 AT32F413 zero-wait/non-zero-wait Flash and embedded SRAM configurations

Except for AT32F413C8T7, other parts supports the allocation of internal Flash memory and SRAM through user system data configurations.

Taking AT32F413RCT7 as an example, the internal Flash memory and SRAM can be configured as one of the followings:

- ZW: 96 KB, NZW: 160 KB, SRAM: 32 KB (factory default);
- ZW: 64 KB, NZW: 192 KB, SRAM: 64 KB;
- ZW: 112 KB, NZW: 144 KB, SRAM: 16 KB.

The core reads the command code stored in zero-wait Flash without any latency, and it is unnecessary to insert any wait state. For example, if the system clock is 200 MHz and AT32F413 zero-wait Flash is 96 KB, the first 96 KB of a 128 KB bin file can be executed at 200 MHz, and the later 32 KB bin file is stored in the non-zero wait area and executed at 80 MHz, which is faster than 72 MHz (the maximum frequency of SXX32F10X). The execution rate of non-zero-wait area is 0.4 times that of the zero-wait area.

Embedded SRAM 16 KB/32 KB (default)/64 KB, which can be selected in any of the following ways:

To configure the AT32F413 SRAM size, the user needs to refer to the description of FLASH user system data and set EOPB0 (address: 0x1FFF_F810). EOPB0=0x0(0x2) indicates that the on-chip SRAM is 64 KB; EOPB0=0x1 indicates that the on-chip SRAM is 16 KB; EOPB0=0x3 indicates that the on-chip SRAM is 32 KB. **To enable EOPB0, a power-off or RESET must occur once.**

The following section takes AT32F413RCT7 as an example to introduce how to configure SRAM size through ICP/ISP. For more information about the principle and method of SRAM expansion, please refer to AN0026_Extending_SRAM_in_User's_Program ([ARTERY's official website](#)→ SUPPORT→AP Note→AN0026).

■ Artery ICP Programmer (BOOT0=0, BOOT1=0)

Connect AT-Link /J-Link to MCU—Open Artery ICP Programmer—User system data—Select EOPB0 **16 KB/32 KB/64 KB** (complete other relevant settings if any) — Apply to device.

Figure 25. User system data in ICP Programmer

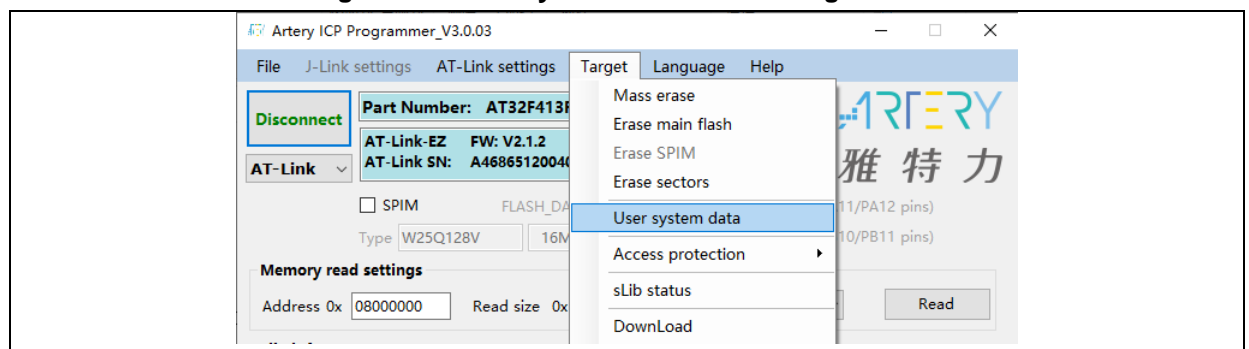
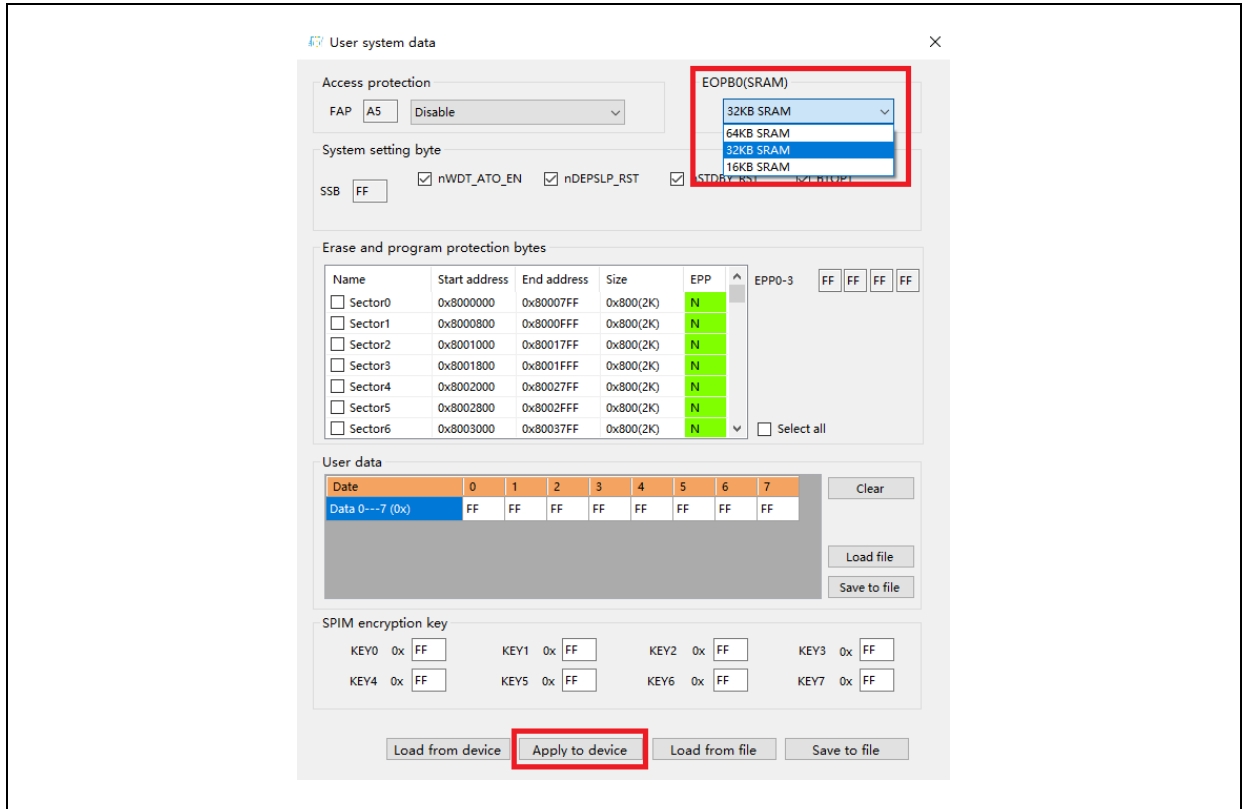

Figure 26. Select SRAM size in user system data



■ Artery ISP Programmer (BOOT0=1, BOOT1=0)

Connect UART or USB to MCU—Click on “Next” until enter the final interface—Select “Edit User system data”—Next— Select EOPB0 **16 KB/32 KB/64 KB** (complete other relevant settings if any) — Apply to device.

Figure 27. Edit user system data in ISP Programmer



■ Artery ISP Multi-Port Programmer (BOOT0=1, BOOT1=0)

Select the port to be used—download user system data file after the port is recognized successfully—Edit—Select **16 KB/32 KB/64 KB**—Save to file (create a user system data program file)—Close—Start, or download user system data file—Open (the saved user system data program file) —Start.

Figure 28. User system data setting in ISP Multi-Port Programmer

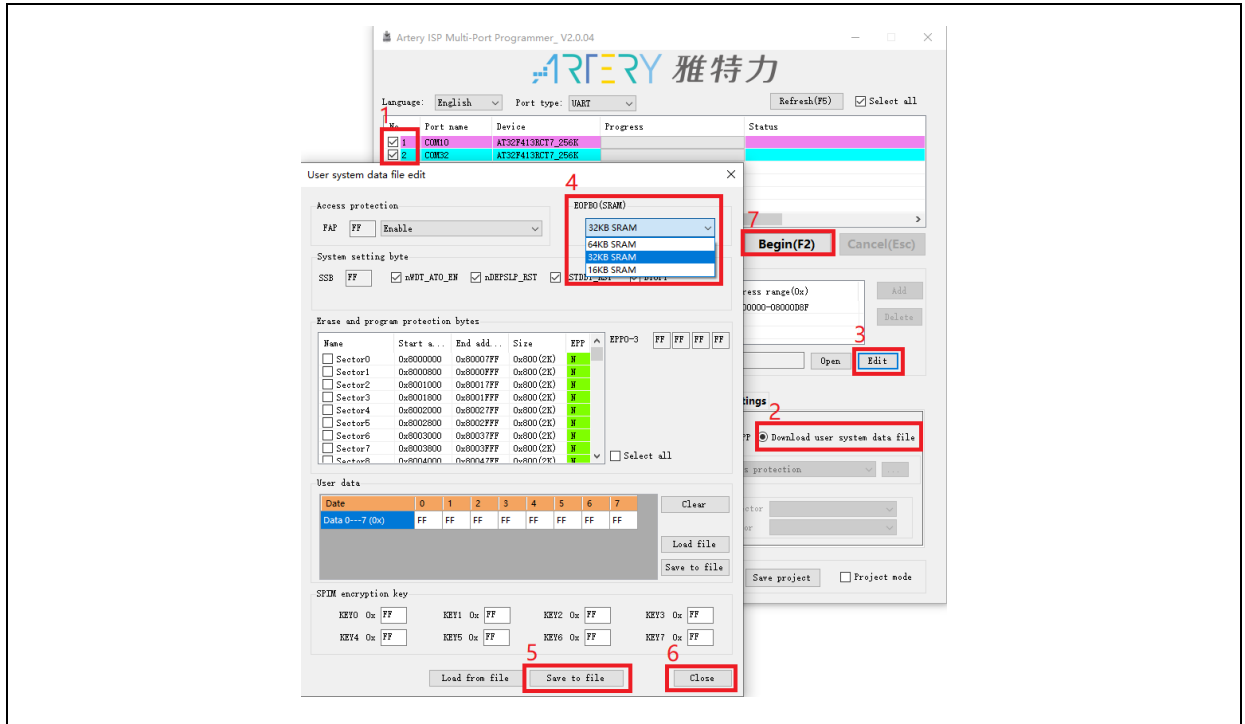

It is not recommended to use APP program to modify the SRAM size, for the reason that if the SRAM used in the APP is larger than the modified SRAM, the program will enter hardfault.

1.2.4 Encryption mode (access protection /erase and program protection /external Flash encryption)

1.2.4.1 Access protection

The access protection is commonly known as “encryption”, which is applied to the entire Flash storage area. Once the Flash access protection is enabled, the embedded Flash storage area can only be read through normal execution of the program, not through JTAG or SWD. When ICP/ISP tool is used to disable the access protection, the chip will perform erase operation on the Flash.

The ICP/ISP tool can be used to enable and disable IC access protection, as shown below:

■ Artery ICP Programmer (BOOT0=0, BOOT1=0)

Enable access protection: Open Artery ICP Programmer—Access protection—Enable (Y).

Disable access protection: Open Artery ICP Programmer-- Access protection—Disable (Y).

■ Artery ISP Programmer (BOOT0=1, BOOT1=0)

Enable access protection: Protection/Enable/Access protection--Next—Yes, encrypted.

Disable access protection: Protection/Disable/Access protection--Next—Yes, Flash decrypted.

Figure 29. Enable access protection in ISP Programmer

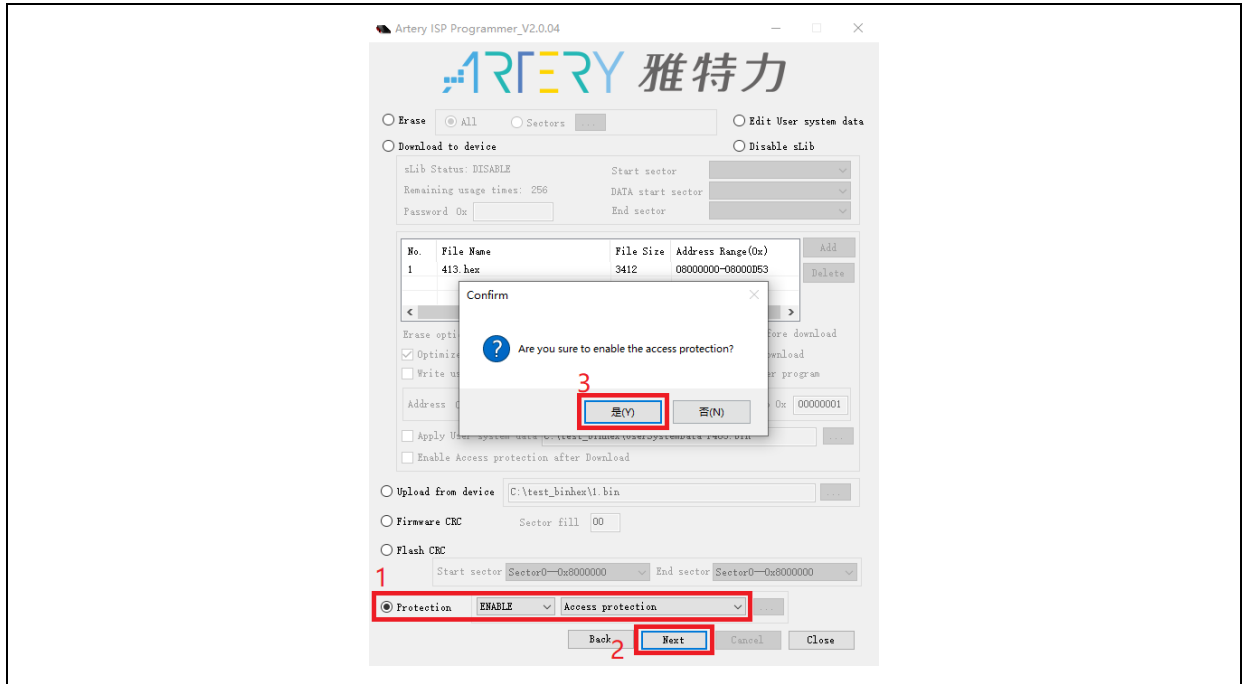
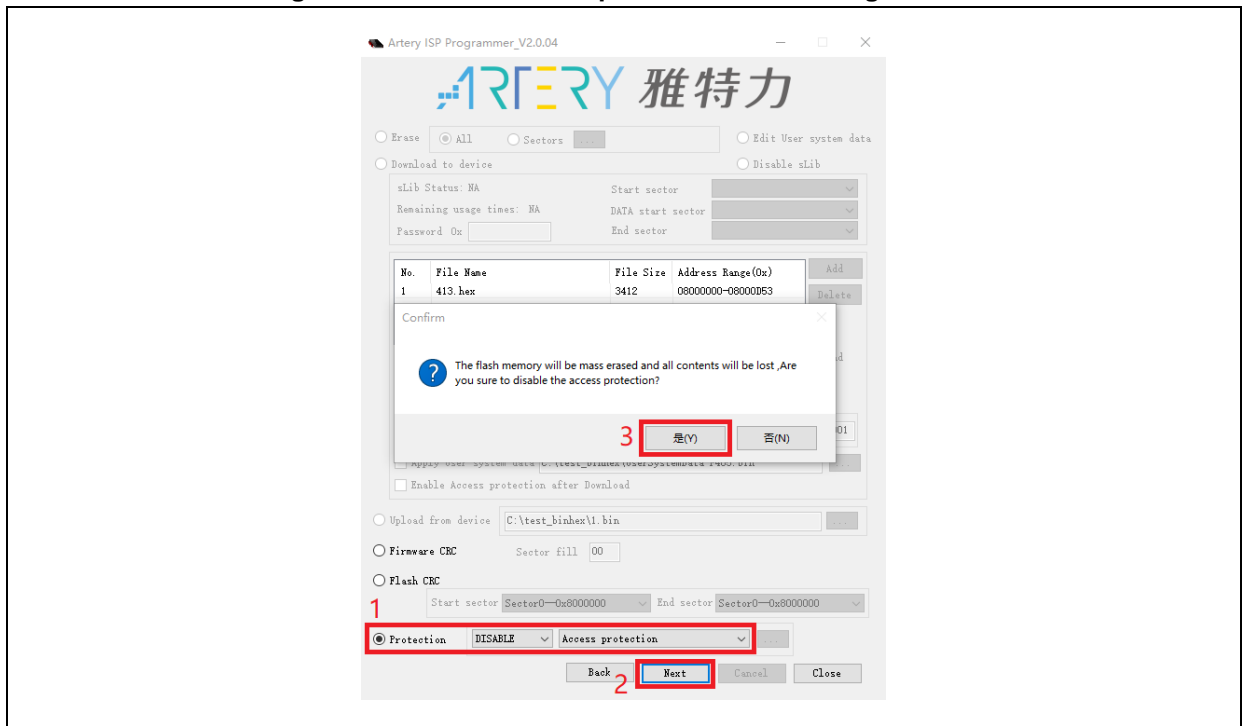

Figure 30. Disable access protection in ISP Programmer



■ Artery ISP Multi-Port Programmer (BOOT0=1, BOOT1=0)

Enable access protection: Protection/Enable/Access protection—Start—Yes, encrypted.

Disable access protection: Protection/Disable/Access protection—Start—Yes, Flash decrypted.

Note: Once enabled, the access protection cannot be disabled through erase operation.

1.2.4.2 Erase and program protection

The program protection is applied to the entire Flash storage area or certain pages in the Flash storage area. Once the Flash program protection is enabled, the internal Flash storage area cannot be programmed in any way.

The user can use ICP/ISP programmer to enable/disable erase and program protection, as shown below:

■ Artery ICP Programmer (BOOT0=0, BOOT1=0)

Enable erase and program protection: Open Artery ICP Programmer—User system data—Tick the sectors that require erase and program protection—Apply to device.

Disable erase and program protection: Open Artery ICP Programmer—User system data—Untick the sectors that do not require erase and program protection—Apply to device.

Figure 31. Enable erase and program protection in ICP Programmer

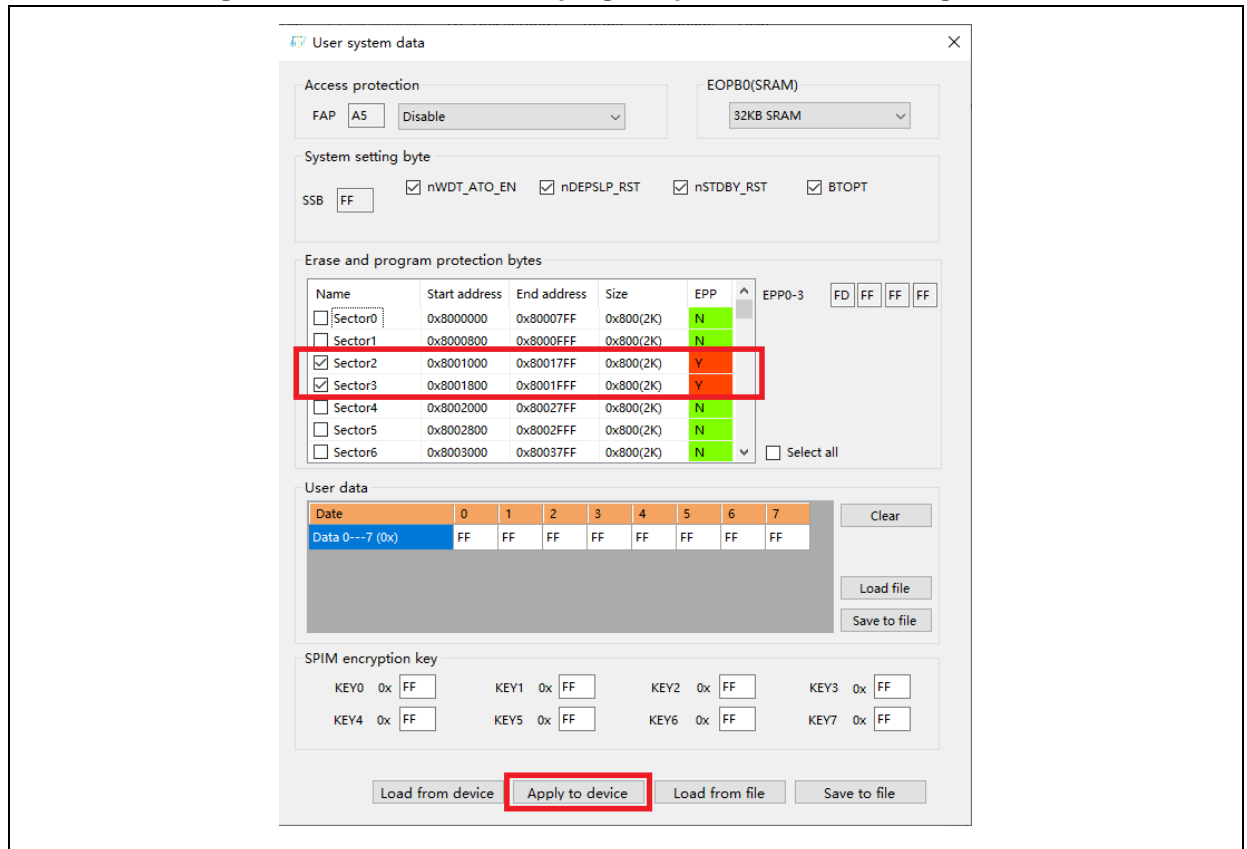
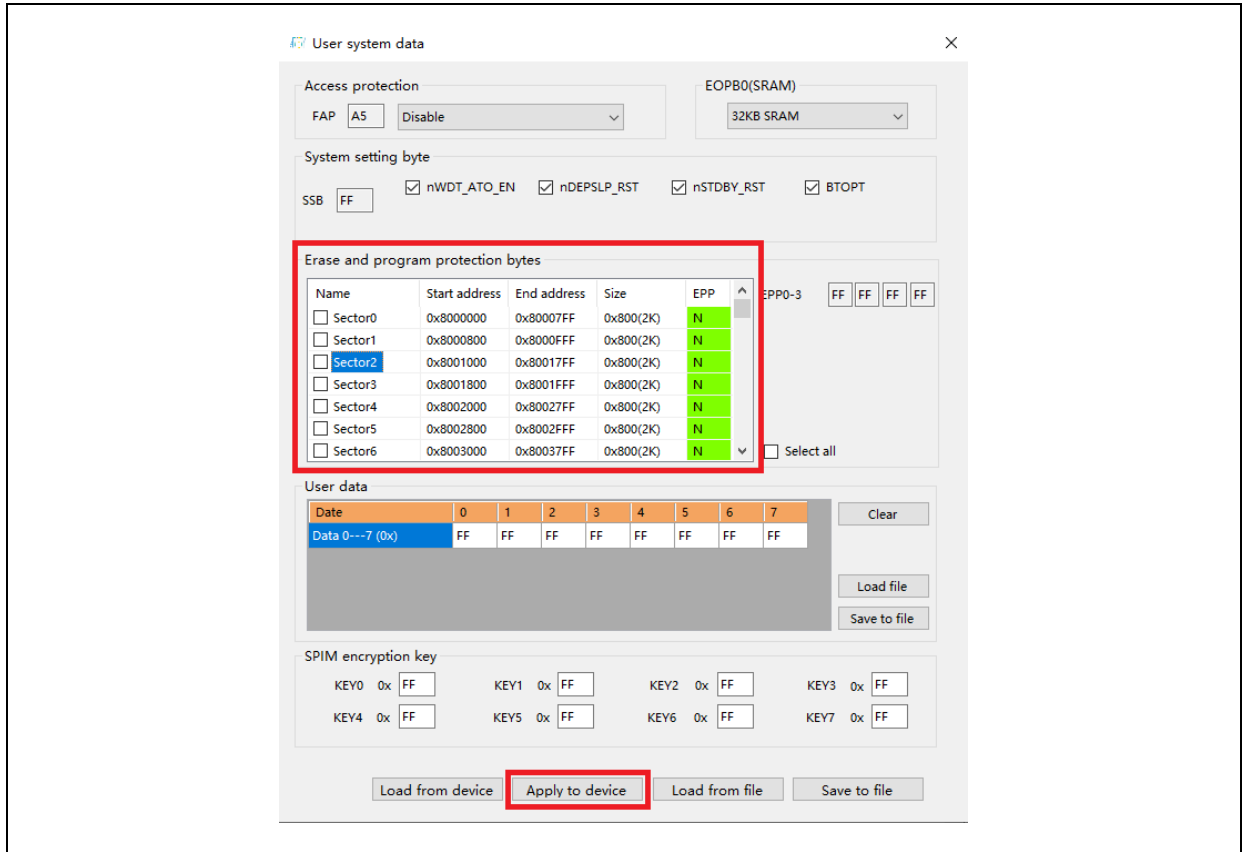

Figure 32. Disable erase and program protection in ICP Programmer



- Artery ISP Programmer (BOOT0=1, BOOT1=0)
 - Enable erase and program protection: Protection/Enable/Erase and program protection—Next—Yes, erase and program protection enabled.
 - Disable erase and program protection: Protection/Disable/Erase and program protection—Next—Yes, erase and program protection disabled.
- Artery ISP Multi-Port Programmer (BOOT0=1, BOOT1=0)
 - Enable erase and program protection: Protection/Enable/Erase and program protection—Start—Yes, erase and program protection enabled.
 - Disable erase and program protection: Protection/Disable/Erase and program protection—Start—Yes, erase and program protection disabled.

Note: Once enabled, the erase and program protection cannot be disabled through erase operation.

1.2.4.3 External Flash encryption (encryption of downloading and reading the data within the encrypted range of external memory)

For external Flash encryption, the user needs to set the encryption range and password as shown below, program the user program, and then enable access protection. The encryption range indicates the size of the space to be encrypted starting from 0x08400000. If the encryption keys are all 0xFF or 0x00, do not encrypt the external Flash; otherwise, encrypt the external Flash. Disabling access protection will set the external Flash encryption keys all to 0xFF.

Use ICP/ISP programmer to encrypt the external memory as follows:

- Artery ICP Programmer (BOOT0=0, BOOT1=0)
 - Tick the external memory—Select the external memory type—Set the encryption range—

Device operation—User system data—Modify the encryption key—Apply to device.

Figure 33. Encrypt external memory in ICP Programmer

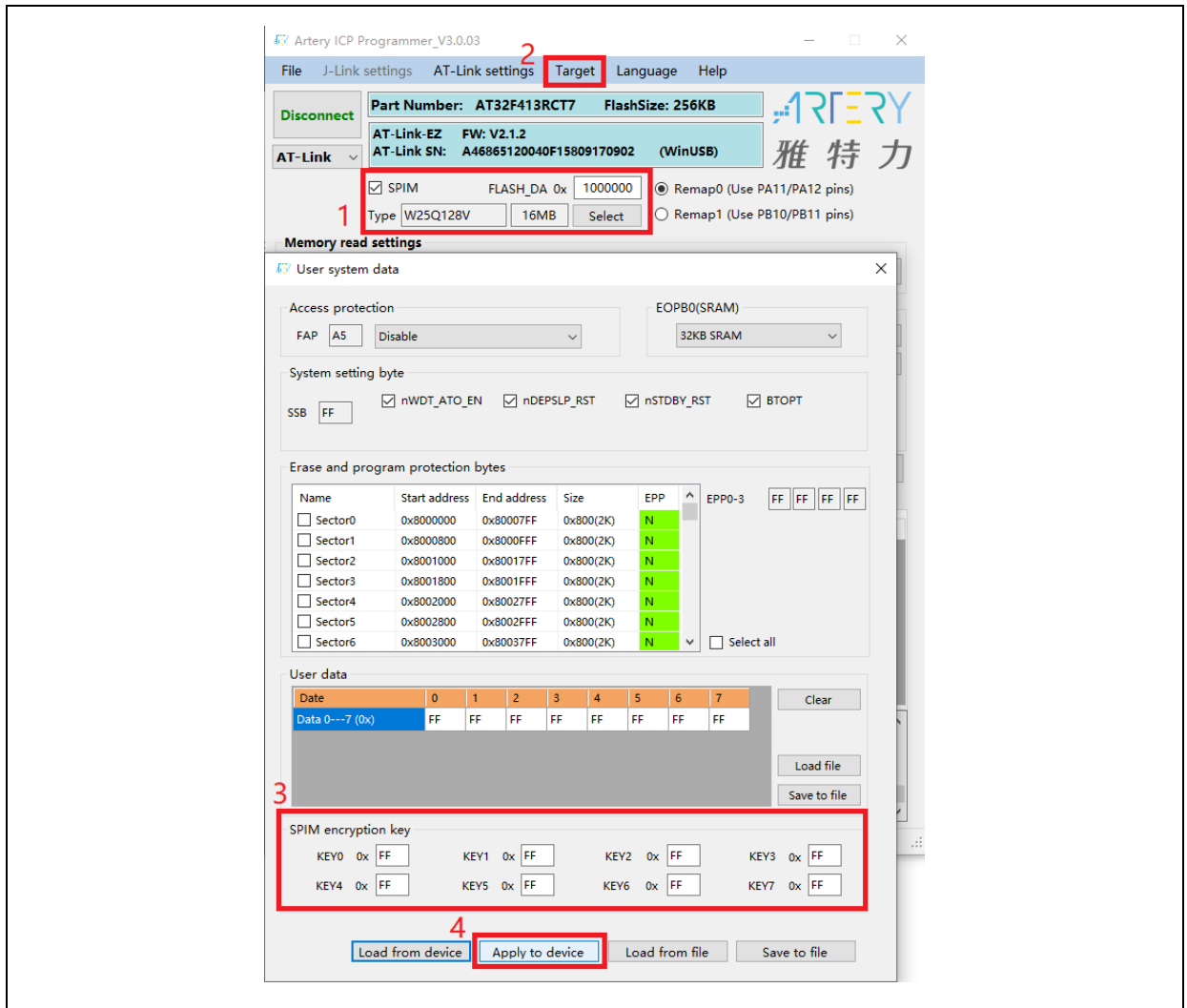

- Artery ISP Programmer (BOOT0=1, BOOT1=0)

Edit user system data—Next—Modify the encryption key—Apply to device.

Figure 34. Encrypt external memory in ISP Programmer

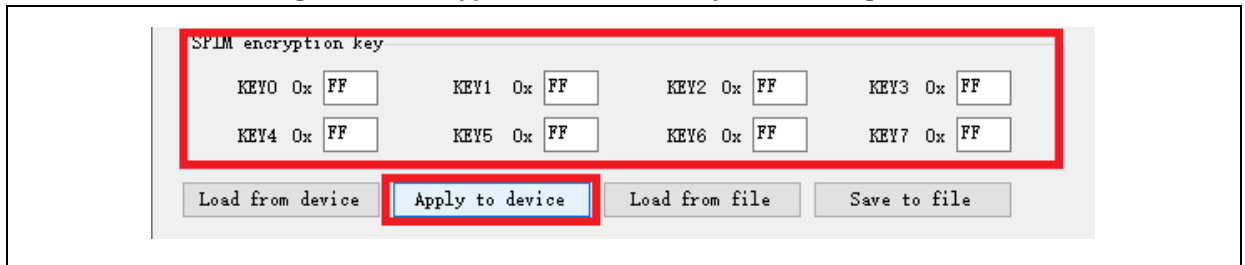

- Artery ISP Multi-Port Programmer (BOOT0=1, BOOT1=0)

Download user system data file—Edit—Modify the encryption key—Save to file—Start.

1.2.5 Recognize AT32 MCU in program

■ Read Cortex-M CPU ID to identify M0, M3 and M4 core

Figure 35. Read Cortex ID

```
cortex_id = *(uint32_t*)0xE000ED00;// Read Cortex ID

if((cortex_id & 0xC241) == 0xC241)
{
    printf("This chip is Cortex-M4F.\r\n");
}
else
{
    printf("This chip is Other Device.\r\n");
}
```

■ Read PID and UID

Figure 36. Read PID and UID

```
/* Get the base address of AT32 MCU PID/UID */
#define DEVICE_ID_ADDR1 0xFFFF7F3 // Define Artery MCU part number, UID base address
#define DEVICE_ID_ADDR2 0xE0042000 // Define MCU device number, PID base address

/* Used to store ID */
uint8_t ID[5] = {0};

/* AT32F413 MCU type table */
const uint64_t AT32_MCU_ID_TABLE[] =
{
    0x0000000470030240, //AT32F413RCT7 256KB LQFP64
    0x00000004700301C1, //AT32F413RBT7 128KB LQFP64
    ...
};

/* Get PID/UID */
ID[0] = *(int*)DEVICE_ID_ADDR1;
ID[1] = *(int*)(DEVICE_ID_ADDR2+3);
ID[2] = *(int*)(DEVICE_ID_ADDR2+2);
ID[3] = *(int*)(DEVICE_ID_ADDR2+1);
ID[4] = *(int*)(DEVICE_ID_ADDR2+0);

/* Combine PID/UID */
AT_device_id =
((uint64_t)ID[0]<<32)|((uint64_t)ID[1]<<24)|((uint64_t)ID[2]<<16)|((uint64_t)ID[3]<<8)|((uint64_t)ID[4]<<0);

/* Judge AT32 MCU */
for(i=0;i<sizeof(AT32_MCU_ID_TABLE)/sizeof(AT32_MCU_ID_TABLE[0]);i++)
{
    if(AT_device_id == AT32_MCU_ID_TABLE[i])
    {
        printf("This chip is AT32F4xx.\r\n");
    }
    else
    {
        printf("This chip is Other Device.\r\n");
    }
}
```

Note: AT32F4xx MCU contains multiple ID codes. Combine the obtained ID information to a 64-bit data to help identify the specific MCU model. For more information, please refer to the Reference Manual (DEBUG section) of each series and *AN0016_Recognize_AT32_MCU* ([ARTERY's official website](#)→SUPPORT→AP Note→AN0016).

2 FAQs in downloading/compiling

2.1 Hard Fault Handler

- The SRAM being used exceeds the specified SRAM in user system date.
Please refer to Section [1.2.3](#) and use ICP/ISP programmer or 3rd party programmer to configure a larger SRAM space before programming.
- The single precision function is enabled in Keil or IAR, while the M4 core FPU register is not enabled in the code. Please enable FPU function in the code:

Figure 37. Add FPU enabling codes

```
void SystemInit(void)
{
    /* Enable FPU*/
    #if defined (__FPU_USED) && (__FPU_USED == 1U)
        SCB->CPACR |= ((3U << 10U * 2U) |          /* set CP10 Full Access */
                    (3U << 11U * 2U) );          /* set CP11 Full Access */
    #endif
}
```

- The data being accessed is out of range.
Find out the access violation point and modify the data to the normal range.
- The system clock configuration is out of specification.

2.2 J-Link cannot find IC

- Please refer to *FAQ0008_J-Link cannot find IC* ([ARTERY's official website](#)→SUPPORT→FAQ→FAQ0008).
- Please refer to *FAQ0132_Add Artery MCU to J-Link* ([ARTERY's official website](#)→SUPPORT→FAQ→FAQ0132).

2.3 Problems in program downloading

2.3.1 Error: Flash Download failed–“Cortex-M4”

The following pop-up window appears in KEIL emulation or downloading:

Figure 38. Flash Download failed–“Cortex- M4” pops up in downloading

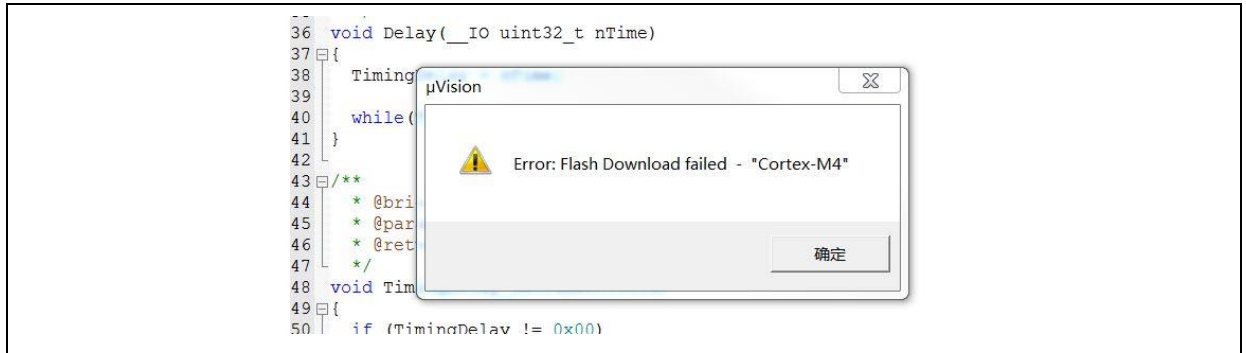

This pop-up window may appear in one of the following conditions:

- The access protection is enabled. Please disable MCU access protection and then download.
- The selected Flash file algorithm is incorrect or no Flash file algorithm is loaded. Please add the proper Flash file algorithm in “Flash Download”.
- BOOT0 and BOOT1 are incorrect. Set BOOT0=0 and BOOT1=0 to allow MCU to boot from the main Flash memory.
- The J-Link version is outdated. Please use 6.20C and above.
- JTAG/SWD PIN is disabled in the program. Please refer to “2.3.5 Resume download”.

2.3.2 No Debug Unit Device found

- The download port is occupied. For example, ICP is connecting to the target device.
- JTAG/SWD connection error or not connected.

2.3.3 RDDI-DAP Error

- Compiler optimization level is too high. For example, the default optimization level of Keil AC6 is -Oz, which should be changed to -O0/-O1.
- JTAG/SWD PIN is disabled in the program. Please refer to “2.3.5 Resume download”.

2.3.4 ISP serial port gets stuck in downloading

When the ISP serial port is used for downloading, it may be stuck occasionally, and the PC cannot release serial port in this case.

The following operations are recommended:

- Check whether the power supply is stable;
- Replace with better USB-to-serial port tools, i.e., CH340 chip.

2.3.5 Resume download

When using AT32F4103, the user may not be able to download the program again in the following conditions:

- After disabling JTAG/SWD PIN in the program, the program cannot be downloaded and JTAG/SWD device is not found.

- After entering Standby mode, the program cannot be downloaded and JTAG/SWD device is not found.

Solutions in KEIL and IAR are as follows:

- Solution 1: Use the ConfigureJLink.exe provided by ARTERY;
- Solution 2: Switch boot mode: switch to Boot[1:0]=01b or Boot[1:0]=11b, and then press "Reset" button to resume download (note: switch back to Boot[1:0]=00b). Similarly, ISP download can be resumed.
- Solution 3: ICP tool + AT-Link
AT-Link is specially designed for AT32 MCUs. The ICP can be used together with AT-Link to resume download. Solution 2 and Solution 3 require Boot PIN or device (AT-Link) additionally; therefore, this application note mainly introduces Solution 1.

2.3.5.1 Solutions in KEIL

Use the ConfigureJLink.exe provided by ARTERY.

The following procedures are recommended:

- Place the ConfigJLink_V1.0.0.exe into the directory where the project file (*.uvprojx) is located;
- Double click the ConfigJLink_V1.0.0.exe, and the following window (as shown in Figure 39) will pop up;
- Tick "Agree" and then click on "OK"; then the progress bar will pop up (as shown in Figure 40), and wait for the erase progress is completed, and then the program can be downloaded.

Figure 39. Operate ConfigJLink_V1.0.0 in KEIL

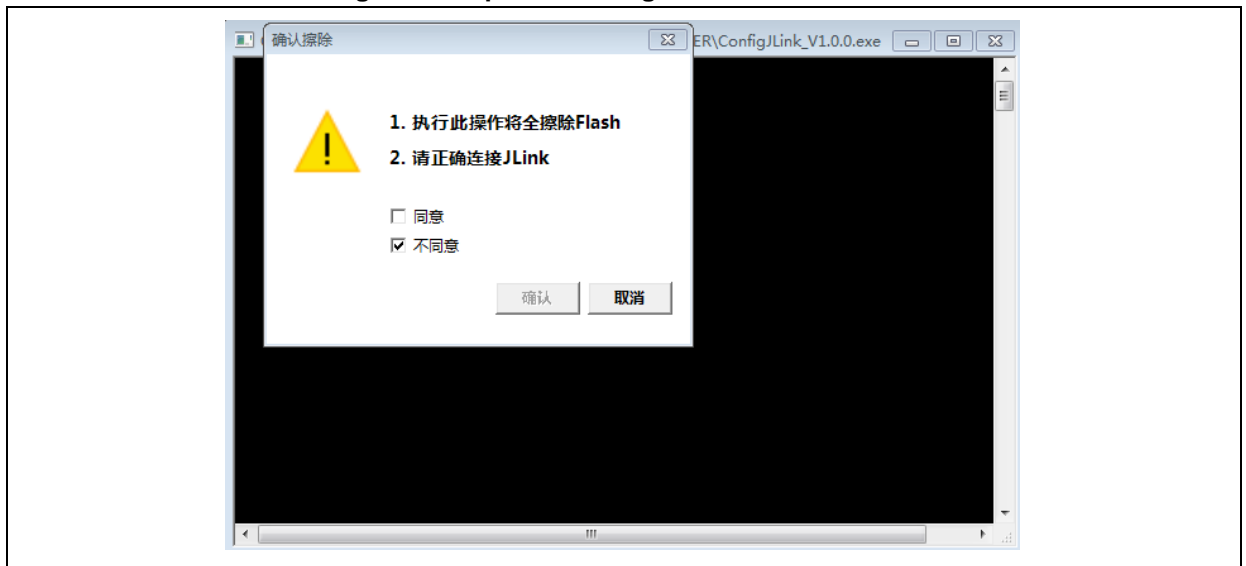
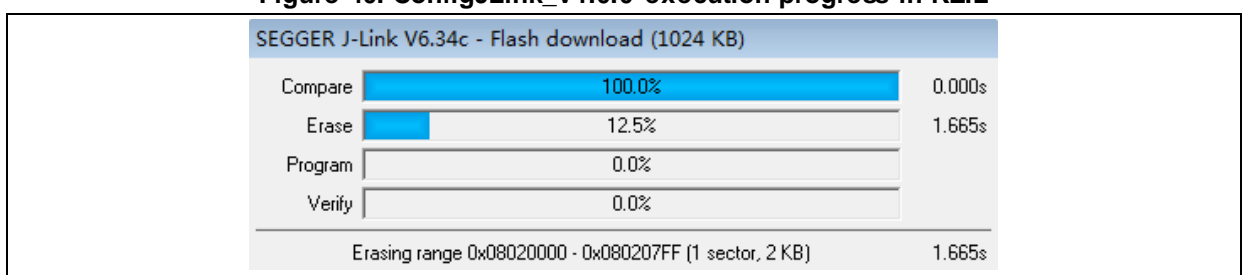

Figure 40. ConfigJLink_V1.0.0 execution progress in KEIL



Note 1: Make sure that SEGGER J-Link interface DLL is not lower than V6.14.

Note 2: If JTAG/SWD PIN is disabled every time the program is downloaded, perform the preceding steps before downloading the program.

Note 3: If the MCU enters Standby mode every time the program is downloaded, perform the preceding steps before the chip is powered on.

Note 4: In Keil, after AT32F413 MCU enters Standby mode, the solution using ConfigureJLink.exe is invalid.

2.3.5.2 Solutions in IAR

Use the ConfigJLink_V1.0.0.exe provided by ARTERY.

The following procedures are recommended:

- Place the ConfigJLink_V1.0.0.exe to the *settings* folder under the project directory.
- Double click the ConfigJLink_V1.0.0.exe, and the following window (as shown in Figure 41) will pop up.
- Tick “Agree” and then click on “OK”; then the progress bar will pop up (as shown in Figure 42), and wait for the erase progress is completed, and then the program can be downloaded.

Figure 41. Operate ConfigJLink_V1.0.0 in IAR



Figure 42. ConfigJLink_V1.0.0 execution progress in IAR

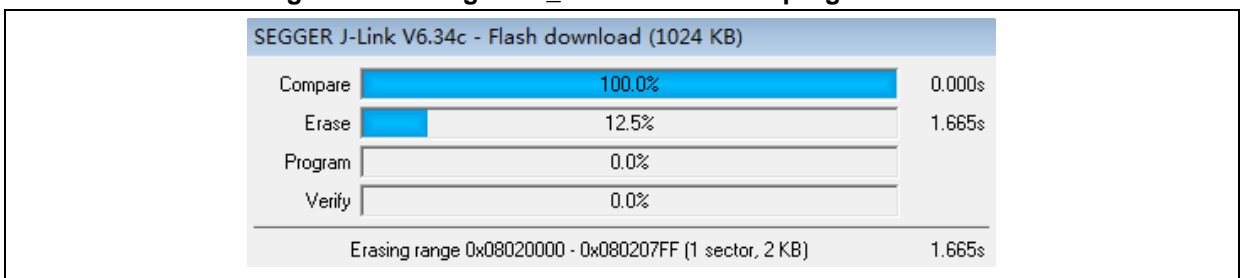

Note 1: Make sure that SEGGER J-Link interface DLL is not lower than V6.14.

Note 2: If JTAG/SWD PIN is disabled every time the program is downloaded, perform the preceding steps before downloading the program.

Note 3: If the MCU enters Standby mode every time the program is downloaded, perform the preceding steps before the chip is powered on.

3 Security Library (sLib)

3.1 Introduction

As more and more MCU applications require complex algorithms and middleware solutions, it has become an important issue that how to protect IP-Codes (such as core algorithms) developed by software solution providers.

The AT32F413 series is designed with a security library (sLib) to protect important IP-Codes against being changed or read by the end user's program.

3.2 Principles of application

- Security library (sLib) is a defined area protected by a code in the main memory. Software solution providers store core algorithms in sLib for protection. The rest of the area can be used for secondary development by terminal customers.
- Security library includes the instruction security library (SLIB_INSTRUCTION) and data security library (SLIB_DATA). Users can select part of or the whole security library for instruction storage, but using the whole security library for storing data is not supported.
- Program codes in the instruction security library (SLIB_INSTRUCTION) can only be fetched by MCU through I-Code bus (can only be executed) and cannot be read through D-Code (including ISP/ICP debug mode and programs that boot from internal RAM). When accessing the SLIB_INSTRUCTION in the manner of reading data, values are all read 0xFF.
- Data in the data security library (SLIB_DATA) can only be read through D-Code bus and cannot be programmed.
- The program code and data in security library cannot be erased unless the correct code is keyed in. If a wrong code is keyed in, in an attempt of writing or erasing the security library, a warning message will be issued by EPPERR=1 in the FLASH_STS register.
- The program code and data in security library are not erased when the end users perform a mass erase on the main Flash memory.
- Users can write the previously defined password in the SLIB_PWD_CLR register to disable security library protection. When the security library protection is disabled, the chip will perform a mass erase on the main Flash memory (including the contents of security library). Therefore, even if the code defined by the software solution provider is leaked, the program code will not be leaked.

3.3 Security library application

For details, refer to *AN0038_AT32F413_Security_Library_Application_Note* ([ARTERY's official website](#)→SUPPORT→AP Note→AN0038).

4 Revision history

Table 1. Document revision history

Date	Version	Revision note
2021.12.08	2.0.0	Initial release.
2022.08.04	2.0.1	Updated 3 rd party programming tools.
2022.10.09	2.0.2	Added description of development environment and file path.
2022.10.21	2.0.3	Optimized description of UID and PID.

IMPORTANT NOTICE – PLEASE READ CAREFULLY

Purchasers are solely responsible for the selection and use of ARTERY's products and services; ARTERY assumes no liability for purchasers' selection or use of the products and the relevant services.

No license, express or implied, to any intellectual property right is granted by ARTERY herein regardless of the existence of any previous representation in any forms. If any part of this document involves third party's products or services, it does NOT imply that ARTERY authorizes the use of the third party's products or services, or permits any of the intellectual property, or guarantees any uses of the third party's products or services or intellectual property in any way.

Except as provided in ARTERY's terms and conditions of sale for such products, ARTERY disclaims any express or implied warranty, relating to use and/or sale of the products, including but not restricted to liability or warranties relating to merchantability, fitness for a particular purpose (based on the corresponding legal situation in any unjudicial districts), or infringement of any patent, copyright, or other intellectual property right.

ARTERY's products are not designed for the following purposes, and thus not intended for the following uses: (A) Applications that have specific requirements on safety, for example: life-support applications, active implant devices, or systems that have specific requirements on product function safety; (B) Aviation applications; (C) Auto-motive application or environment; (D) Aerospace applications or environment, and/or (E) weapons. Since ARTERY products are not intended for the above-mentioned purposes, if purchasers apply ARTERY products to these purposes, purchasers are solely responsible for any consequences or risks caused, even if any written notice is sent to ARTERY by purchasers; in addition, purchasers are solely responsible for the compliance with all statutory and regulatory requirements regarding these uses.

Any inconsistency of the sold ARTERY products with the statement and/or technical features specification described in this document will immediately cause the invalidity of any warranty granted by ARTERY products or services stated in this document by ARTERY, and ARTERY disclaims any responsibility in any form.

© 2022 ARTERY Technology – All Rights Reserved